

INSPIRON™

SETUP GUIDE



YOURS IS HERE

INSPIRON™

SETUP GUIDE

Regulatory Model: P08F series

Regulatory Type: P08F001

Notes, Cautions, and Warnings



NOTE: A NOTE indicates important information that helps you make better use of your computer.



CAUTION: A CAUTION indicates either potential damage to hardware or loss of data and tells you how to avoid the problem.



WARNING: A WARNING indicates a potential for property damage, personal injury, or death.

If you purchased a Dell™ n Series computer, any references in this document to Microsoft® Windows® operating systems are not applicable.

Information in this document is subject to change without notice.

© 2009 Dell Inc. All rights reserved.

Reproduction of these materials in any manner whatsoever without the written permission of Dell Inc. is strictly forbidden.

Trademarks used in this text: *Dell*, the *DELL* logo, *Inspiron*, *YOURS IS HERE*, *Dell on Call*, and *DellConnect* are trademarks of Dell Inc.; *Intel*, *Pentium*, and *Celeron* are registered trademarks and *Core* is a trademark of Intel Corporation in the U.S. and other countries; *Microsoft*, *Windows*, *Windows Vista*, and *Windows Vista* start button logo are either trademarks or registered trademarks of Microsoft Corporation in the United States and/or other countries; *Blu-ray Disc* is a trademark of the Blu-ray Disc Association; *Bluetooth* is a registered trademark owned by Bluetooth SIG, Inc. and is used by Dell under license.

Other trademarks and trade names may be used in this document to refer to either the entities claiming the marks and names or their products. Dell Inc. disclaims any proprietary interest in trademarks and trade names other than its own.

September 2009

P/N 8X93C

Rev. A00

Contents

Setting Up Your Inspiron Laptop	5	Multimedia Control Keys	28
Before Setting Up Your Computer	5	Using the Optical Drive	30
Connect the AC Adapter	6	Display Features	32
Connect the Network Cable (Optional)	7	Dell Extended Battery Life	34
Press the Power Button	8	Removing and Replacing the Battery	34
Set Up Microsoft Windows	9	Software Features	36
Install the SIM Card (Optional)	10	Dell DataSafe Online Backup	39
Enable or Disable Wireless (Optional)	12	Dell Dock	40
Connect to the Internet (Optional)	14	Solving Problems	41
Using Your Inspiron Laptop	18	Beep Codes	41
Right View Features	18	Network Problems	42
Front View Features	22	Power Problems	43
Computer Base and Keyboard Features	24	Memory Problems	45
Touch Pad Gestures	26	Lockups and Software Problems	46

Contents

Using Support Tools	48	Returning Items for Repair Under Warranty or for Credit.....	66
Dell Support Center.....	48	Before You Call.....	67
System Messages.....	49	Contacting Dell.....	69
Hardware Troubleshooter.....	51		
Dell Diagnostics.....	52	Finding More Information and Resources	70
Restoring Your Operating System	55	Basic Specifications	72
System Restore.....	56	Appendix	78
Dell Factory Image Restore.....	58	Macrovision Product Notice.....	78
Operating System Reinstallation.....	60	Information for NOM, or Official Mexican Standard (Only for Mexico).....	79
Getting Help	62	Index	80
Technical Support and Customer Service.....	63		
DellConnect.....	63		
Online Services.....	64		
Automated Order-Status Service.....	65		
Product Information.....	65		

Setting Up Your Inspiron Laptop

This section provides information about setting up your Dell™ Inspiron™ laptop.

Before Setting Up Your Computer

When positioning your computer, ensure that you allow easy access to a power source, adequate ventilation, and a level surface to place your computer.

Restricting airflow around your Inspiron laptop may cause it to overheat. To prevent overheating ensure that you leave at least 10.2 cm (4 inches) at the back of the computer and a minimum of 5.1 cm (2 inches) on all other sides. You should never place your computer in an enclosed space, such as a cabinet or drawer when it is powered on.



WARNING: Do not block, push objects into, or allow dust to accumulate in the air vents.

Do not place your Dell computer in a low-airflow environment, such as a closed briefcase, while it is powered on. Restricting the airflow can damage the computer or cause a fire.

The computer turns on the fan when the computer gets hot. Fan noise is normal and does not indicate a problem with the fan or the computer.



CAUTION: Placing or stacking heavy or sharp objects on the computer may result in permanent damage to the computer.

Connect the AC Adapter

Connect the AC adapter to the computer and then plug it into a wall outlet or surge protector.

⚠ WARNING: The AC adapter works with electrical outlets worldwide. However, power connectors and power strips vary among countries. Using an incompatible cable or improperly connecting the cable to a power strip or electrical outlet may cause fire or permanent damage to your computer.

✍ NOTE: Connect the power cable to the adapter firmly and ensure that the light on the adapter is on when you turn on power.

✍ NOTE: Use only Dell AC adapter family PA-2E, PA-3E, and PA-12 with your computer.

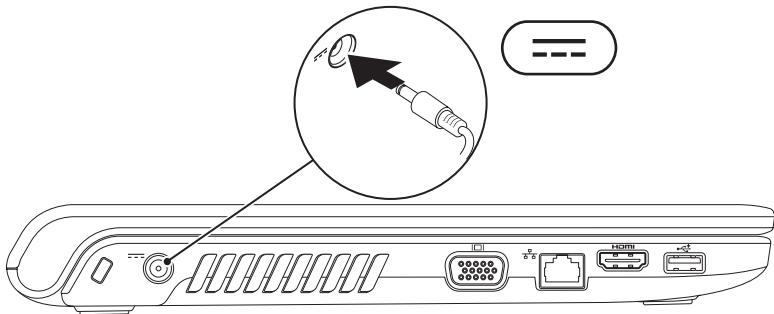

Connect the Network Cable (Optional)

To use a wired network connection, connect the network cable.

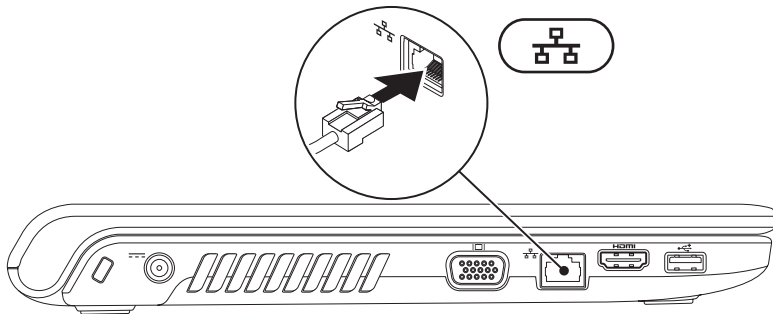

Press the Power Button

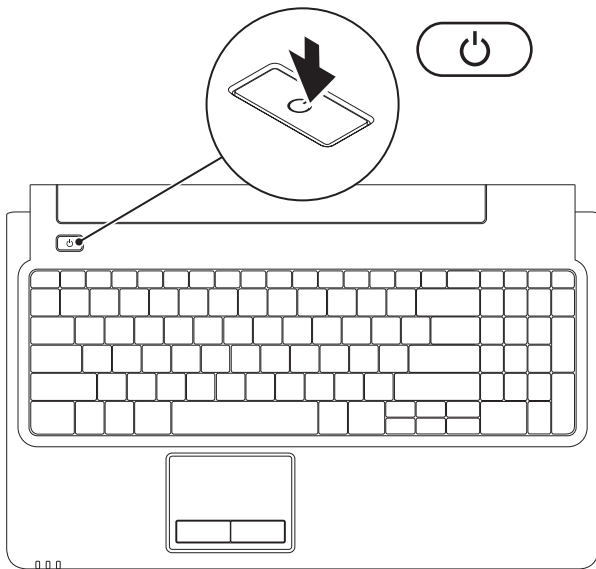

Set Up Microsoft Windows

Your Dell computer is preconfigured with Microsoft® Windows® operating system. To set up Windows for the first time, follow the instructions on the screen. These steps are mandatory and may take some time to complete. The Windows setup screens will take you through several procedures including accepting license agreements, setting preferences, and setting up an Internet connection.

 **CAUTION:** Do not interrupt the operating system's setup process. Doing so may render your computer unusable and you will need to reinstall the operating system.

 **NOTE:** For optimal performance of your computer, it is recommended that you download and install the latest BIOS and drivers for your computer available at support.dell.com.

Install the SIM Card (Optional)

Installing a Subscriber Identity Module (SIM) card allows you to browse the Internet, check e-mail, and connect to a Virtual Private Network. To access these features, you must be within the network of your cellular service provider.

- 1 SIM card
- 2 SIM card slot
- 3 battery bay

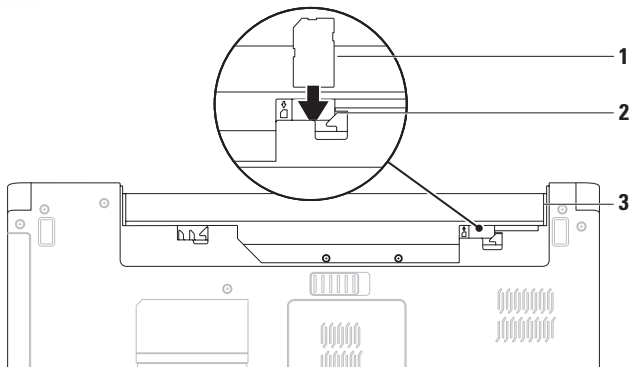

To install the SIM card:

1. Turn off your computer.
2. Remove the battery (see “Removing and Replacing the Battery” on page 34).
3. In the battery bay, slide the SIM card into the SIM card slot.
4. Replace the battery (see “Removing and Replacing the Battery” on page 34).
5. Turn on your computer.

To remove the SIM card, press and eject the SIM card.

Enable or Disable Wireless (Optional)

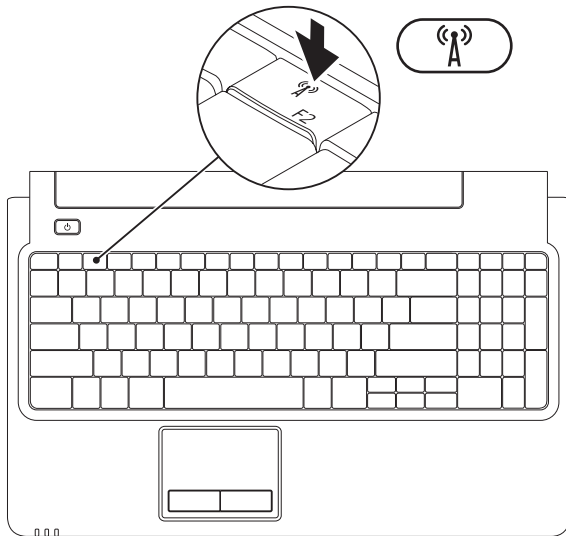

To enable wireless:

1. Ensure that your computer is turned on.
2. Press the wireless key  on the keyboard.

A confirmation of your selection appears on the screen.

Wireless enabled



Wireless disabled

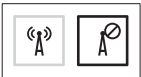

To disable wireless:

Press the wireless key  on the keyboard again to turn off all radios.

-  **NOTE:** The wireless key allows you to quickly turn off all wireless radios (WiFi and Bluetooth®) on your computer, such as when you are asked to disable all wireless radios on an airplane flight.

Connect to the Internet (Optional)

To connect to the Internet, you need an external modem or network connection and an Internet Service Provider (ISP).

If an external USB modem or WLAN adapter is not a part of your original order, you can purchase one from **www.dell.com**.

Setting Up a Wired Connection

- If you are using a DSL or cable/satellite modem connection, contact your ISP or cellular telephone service for setup instructions.
- If you are using a dial-up connection, connect the telephone line to the optional external USB modem and to the telephone wall connector before you set up your Internet connection.

To complete setting up your wired Internet connection, follow the instructions in “Setting Up Your Internet Connection” on page 16.

Setting Up a Wireless Connection

 **NOTE:** To set up your wireless router, see the documentation that shipped with your router.

Before you can use your wireless Internet connection, you need to connect to your wireless router.

To set up your connection to a wireless router:

Windows Vista[®]

1. Ensure that wireless is enabled on your computer (see “Enable or Disable Wireless” on page 12).
2. Save and close any open files, and exit any open programs.
3. Click **Start**  → **Connect To**.
4. Follow the instructions on the screen to complete the setup.

Windows[®] 7

1. Ensure that wireless is enabled on your computer (see “Enable or Disable Wireless” on page 12).
2. Save and close any open files, and exit any open programs.
3. Click **Start**  → **Control Panel** → **Network and Sharing Center** → **Connect to a network**.
4. Follow the instructions on the screen to complete the setup.

Setting Up Your Internet Connection

ISPs and ISP offerings vary by country. Contact your ISP for offerings available in your country.

If you cannot connect to the Internet but have successfully connected in the past, the ISP might have a service outage. Contact your ISP to check the service status, or try connecting again later.

Have your ISP information ready. If you do not have an ISP, the **Connect to the Internet** wizard can help you get one.

To set up your Internet connection:

Windows Vista

 **NOTE:** The following instructions are applicable to the Windows default view, so they may not apply if you set your Dell™ computer to the Windows Classic view.

1. Save and close any open files, and exit any open programs.
2. Click **Start**  → **Control Panel** → **Network and Internet** → **Network and Sharing Center** → **Set up a connection or network** → **Connect to the Internet**.

The **Connect to the Internet** window appears.

 **NOTE:** If you do not know which type of connection to select, click **Help me choose** or contact your ISP.

3. Follow the instructions on the screen and use the setup information provided by your ISP to complete the setup.

Windows 7

1. Save and close any open files, and exit any open programs.
2. Click **Start**  → **Control Panel** → **Network and Sharing Center** → **Set up a new connection or network** → **Connect to the Internet**.

The **Connect to the Internet** window appears.

-  **NOTE:** If you do not know which type of connection to select, click **Help me choose** or contact your ISP.
3. Follow the instructions on the screen and use the setup information provided by your ISP to complete the setup.

Using Your Inspiron Laptop

This section provides information about the features available on your Inspiron laptop.

Right View Features

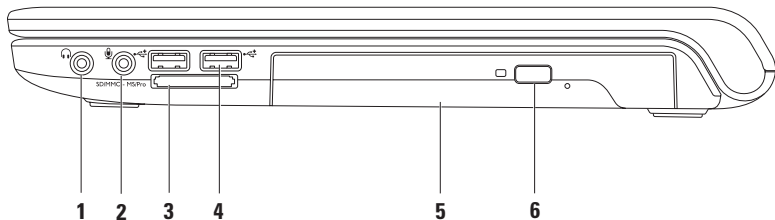

1  **Audio out/Headphone connector** — Connects to a pair of headphones or to a powered speaker or sound system.

2  **Audio in/Microphone connector** — Connects to a microphone or inputs signal for use with audio programs.

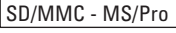
3  **7-in-1 media card reader** — Provides a fast and convenient way to view and share digital photos, music, videos, and documents stored on the following digital media cards:

- Secure Digital (SD) memory card
- Secure Digital High Capacity (SDHC) card
- Multi Media Card (MMC)
- MMC+
- Memory Stick
- Memory Stick PRO
- xD-Picture Card (type - M and type - H)

NOTE: Your computer ships with a plastic blank installed in the media card slot. Blanks protect unused slots from dust and other particles. Save the blank for use when no media card is installed in the slot. Blanks from other computers may not fit your computer.

4  **USB 2.0 connectors (2)** — Connect to USB devices, such as a mouse, keyboard, printer, external drive, or MP3 player.

5 **Optical drive** — Plays or records CDs, DVDs, or Blu-ray Discs (optional). Ensure that the side with print or writing is facing upward when placing discs on the optical drive tray.

6 **Eject button** — Ejects the optical drive tray when pressed.

Left View Features

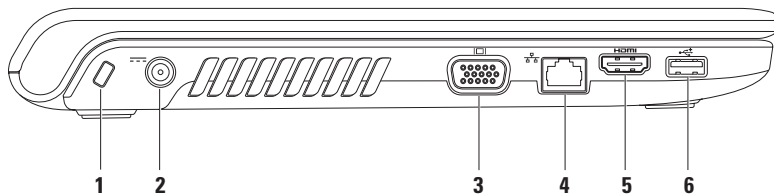

1 Security cable slot — Attaches a commercially available security cable to the computer.

NOTE: Before you buy a security cable, ensure that it works with the security cable slot on your computer.

2  **AC adapter connector** — Connects to the AC adapter to power the computer and charge the battery.

3  **VGA connector** — Connects to a monitor or projector.

4  **Network connector** — Connects your computer to a network or a broadband device if you are using a wired network.

5  **HDMI connector** — Connects to a TV for both 5.1 audio and video signals.

NOTE: When used with a monitor, only the video signal is read.

6  **USB 2.0 connector** — Connects to USB devices, such as a mouse, keyboard, printer, external drive, or MP3 player.

Front View Features

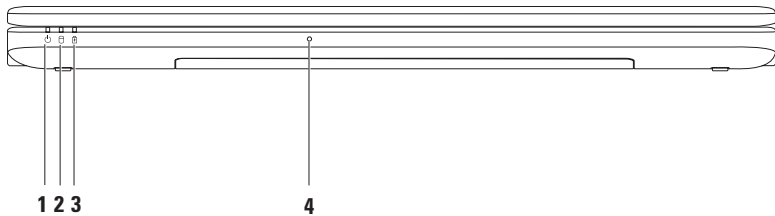

1  **Power indicator light** — Indicates the following power states:

- Solid white — The computer is on.
 - Breathing white — The computer is in standby mode.
 - Off — The computer is off or in hibernate state.
-

2  **Hard drive indicator light** — Turns on when the computer reads or writes data. A blinking light indicates hard drive activity.

3  **Battery indicator light** — Indicates the following states when the computer is powered using either the AC adapter or the battery.



	Indicator light status	Computer state(s)	Battery charge level
AC adapter	Solid white	on/off/standby/hibernate	<98%
	off	on/off/standby/hibernate	>98%
Battery	Solid amber	on/standby	<=10%
	off	on/off/standby/hibernate	>10%

NOTE: The battery is charging when the computer is powered using an AC adapter.

4 **Analog microphone** — Built-in microphone for conferencing and chatting.

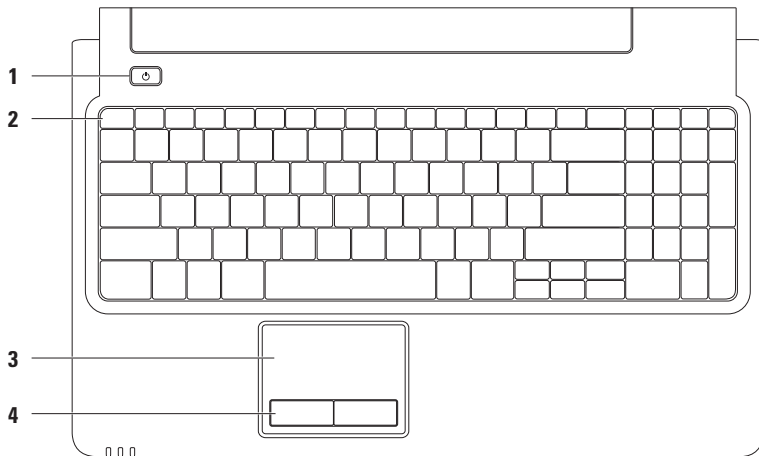
Computer Base and Keyboard Features



-
- 1**  **Power button** — Turns the computer on or off when pressed.
 - 2** **Function key row** — The wireless enable and disable key, brightness increase and decrease keys, multimedia keys, and the touch pad enable or disable key are located in this row.
For more information on the multimedia keys, see “Multimedia Control Keys” on page 28.
 - 3** **Touch pad** — Provides the functionality of a mouse to move the cursor, drag or move selected items, and left-click by tapping the surface. It supports the **Scroll** and **Zoom** features. For more information, see “Touch Pad Gestures” on page 26.
NOTE: To enable or disable the touch pad, press the  key on the function key row on the keyboard.
 - 4** **Touch pad buttons (2)** — Provide left-click and right-click functions like those on a mouse.
-

Touch Pad Gestures

Scroll

Allows you to scroll through content. The scroll feature includes:

Traditional Scroll – Allows you to scroll up and down, or right and left.

To scroll up and down:

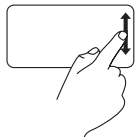

Move a finger up or down in the vertical scroll zone (extreme right of the touch pad).

To scroll right and left:

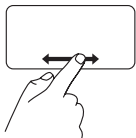

Move a finger right or left in the horizontal scroll zone (extreme bottom of the touch pad).

Circular Scroll – Allows you to scroll up and down, or right and left.

To scroll up and down:

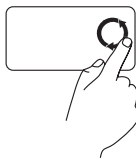

Move a finger in the vertical scroll zone (extreme right of the touch pad), in a counter clockwise circular motion to scroll up or clockwise circular motion to scroll down.

To scroll right and left:

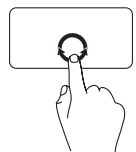

Move a finger in the horizontal scroll zone (extreme bottom of the touch pad), in a clockwise circular motion to scroll right or counterclockwise circular motion to scroll left.

Zoom

Allows you to increase or decrease the magnification of the screen content. The zoom feature includes:

One finger zoom – Allows you to zoom in or out.

To zoom in:

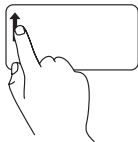

Move a finger up in the zoom zone (extreme left of the touch pad).

To zoom out:

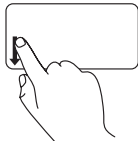

Move a finger down in the zoom zone (extreme left of the touch pad).

Multimedia Control Keys

The multimedia control keys are located on the function key row on the keyboard. To use the multimedia controls, press the required key. You can configure the multimedia control keys on the keyboard using the **Function Key Behavior** in the **System Setup** (BIOS) utility or the **Windows Mobility Center**.

System Setup (BIOS) Utility —

To access the **Function Key Behavior**:

1. Press <F2> during POST (Power On Self Test) to enter the **System Setup** (BIOS) utility.
2. In the **Function Key Behavior**, select **Multimedia Key First** or **Function Key First**.

The options in the **Function Key Behavior** setting are:

Multimedia Key First — This is the default setting. Pressing any multimedia control key performs the associated multimedia action. For function key, press <Fn> + the required function key.

Function Key First — Pressing any function key performs the associated function. For multimedia action, press <Fn> + the required multimedia control key.

 **NOTE:** The **Multimedia Key First** option is active only in the operating system.

Windows Mobility Center —

1. Press < > <X> to launch the Windows Mobility Center.
2. In the **Function Key Row**, select **Function Key** or **Multimedia Key**.



 Mute the sound

 Decrease the volume level

 Increase the volume level

 Play the previous track or chapter

 Play or pause

 Play the next track or chapter

Using the Optical Drive

 **CAUTION:** Do not press down on the optical drive tray when you open or close it. Keep the optical drive tray closed when you are not using the optical drive.

 **CAUTION:** Do not move the computer while playing or recording a disc.

The optical drive plays or records CDs, DVDs, and Blu-ray Discs (optional). Ensure that the side with print or writing is facing upward when placing discs on the optical drive tray.

To place a disc in the optical drive:

1. Press the eject button on the optical drive.
2. Pull out the optical drive tray.
3. Place the disc, label side up, in the center of the optical drive tray and snap the disc onto the spindle.
4. Push the optical drive tray back into the drive.

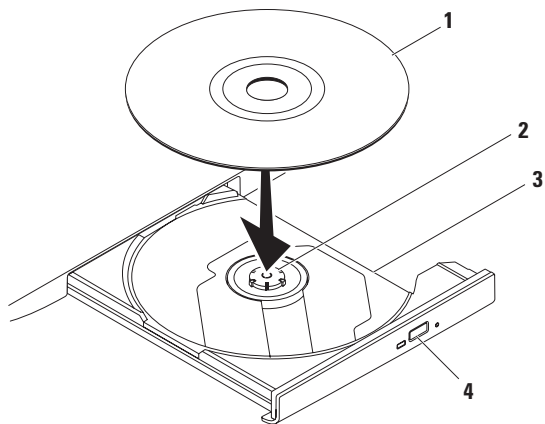

1 disc

2 spindle

3 optical drive tray

4 eject button

Display Features

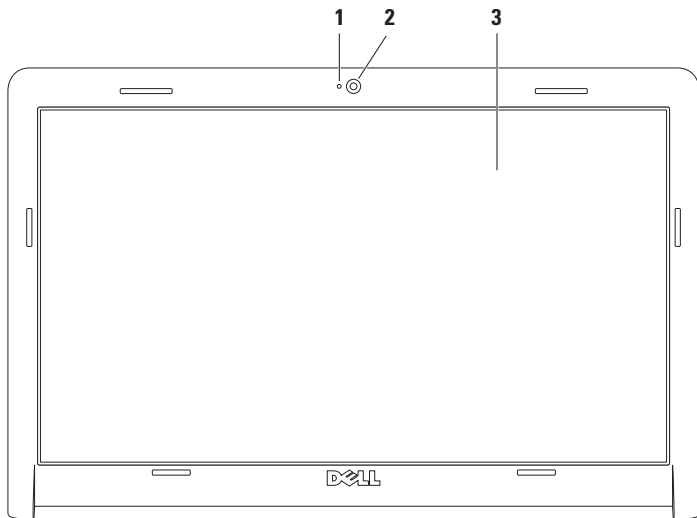

1 Camera activity indicator — Indicates if the camera is on or off.

2 Camera — Built-in camera for video capture, conferencing, and chat.

3 Display — Your display can vary based on selections you made when purchasing your computer. For more information about displays, see the *Dell Technology Guide* available on your hard drive or at support.dell.com/manuals.

Dell Extended Battery Life

The Dell Extended Battery Life feature provides options to derive the maximum backup time from your battery. This feature is enabled by default and is activated when you disconnect the AC power.

Press <F3> to enable or disable the feature. The **Extended Battery Life** pop-up appears to indicate the current status.

To learn more about the customization options for Dell Extended Battery Life:

1. Press <F3>.
The **Extended Battery Life** pop-up appears.
2. Click **Show Settings**.
The **Battery Meter** window appears.
3. Click **What is Dell Extended Battery Life?**

Removing and Replacing the Battery

 **WARNING:** Before you begin any of the procedures in this section, follow the safety instructions that shipped with your computer.

 **WARNING:** Using an incompatible battery may increase the risk of fire or explosion. This computer should only use a battery purchased from Dell. Do not use batteries from other computers.

 **WARNING:** Before removing the battery, shut down the computer, and remove external cables (including the AC adapter).

To remove the battery:

1. Turn off the computer and turn it over.
2. Slide the battery release latch to the unlock position.
3. Slide the battery out of the battery bay.

To replace the battery:

1. Align the tabs on the battery with the slots on the battery bay.
2. Slide the battery into the battery bay until it clicks into place.

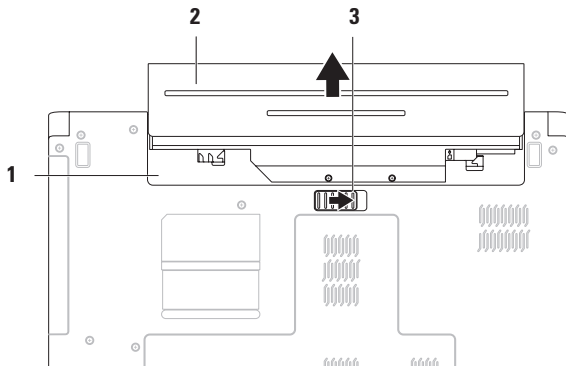

-
- 1 battery bay
 - 2 battery
 - 3 battery release latch
-

Software Features

 **NOTE:** For more information about the features described in this section, see the *Dell Technology Guide* available on your hard drive or at support.dell.com/manuals.

Productivity and Communication

You can use your computer to create presentations, brochures, greeting cards, fliers, and spreadsheets. You can also edit and view digital photographs and images. Check your purchase order for software installed on your computer.

After connecting to the Internet, you can access websites, setup an e-mail account, and upload or download files.

Entertainment and Multimedia

You can use your computer to watch videos, play games, and listen to music or Internet radio stations.

You can download or copy pictures and video files from portable devices, such as digital cameras and cell phones. Optional software applications enable you to organize and create music and video files that can be recorded to disc, saved on portable products such as MP3 players and handheld entertainment devices, or played and viewed directly on connected TVs, projectors, and home theater equipment.

Customizing the Desktop

You can use the customizing options available in your operating system to change the appearance, resolution, wallpaper, screensaver, or other features on your desktop.

To customize your desktop:
Windows Vista[®]

1. Right-click an open area of the desktop.
2. Click **Personalize**, to open the **Personalize appearance and sounds** window and learn more about your customization options.

Windows® 7

1. Right-click an open area of the desktop.
2. Click **Personalize**, to open the **Change the visuals and sounds on your computer** window and learn more about your customization options.

Customizing Your Energy Settings

You can use the power options in your operating system to configure the power settings on your computer. The Microsoft® Windows operating system installed on your Dell computer provides the following options:

Windows Vista

- **Dell Recommended** — Offers full performance when you need it and saves power during periods of inactivity.
- **Power saver** — Saves power on your computer by reducing system performance to maximize the life of the computer and by reducing the amount of energy consumed by your computer over its lifetime.

- **High performance** — Provides the highest level of system performance on your computer by adapting processor speed to your activity and by maximizing system performance.

Windows 7

- **Power saver** — Saves power on your computer by reducing system performance to maximize the life of the computer and by reducing the amount of energy consumed by your computer over its lifetime.
- **Balanced (recommended)** — Automatically balances the performance of your computer by consuming energy on capable hardware.

Transferring Information to a New Computer

To transfer information to a new computer:

Windows Vista

 **NOTE:** The following steps are applicable for the Windows default view, so they may not apply if you set your Dell™ computer to the Windows Classic view.

1. Click **Start**  → **Control Panel** → **System and Maintenance** → **Welcome Center** → **Transfer files and settings**.
If the **User Account Control** window appears, click **Continue**.
2. Follow the instructions on the **Windows Easy Transfer** wizard.

Windows 7

1. Click **Start**  → **Control Panel**.
2. In the search box, type `Transfer` and then click **Transfer files from another computer**.
3. Follow the instructions in the **Windows Easy Transfer** wizard.

Backing Up Your Data

It is recommended that you periodically back up files and folders on your computer.

To back up your data:

Windows Vista

1. Click **Start**  → **Control Panel** → **System and Maintenance** → **Back Up and Restore Center** → **Back up files**.

If the **User Account Control** window appears, click **Continue**.

 **NOTE:** Certain editions of Windows Vista provide an option to back up your computer.

2. Follow the instructions on the **Back Up Files** wizard.

Windows 7

1. Click **Start**  → **Control Panel** → **System and Security** → **Back Up and Restore**.
2. Click **Set up backup...**
3. Follow the instructions on the **Configure Backup** wizard.

Dell DataSafe Online Backup

 **NOTE:** Dell DataSafe® Online may not be available in all regions.

 **NOTE:** A broadband connection is recommended for fast upload/download speeds.

Dell DataSafe Online is an automated backup and recovery service that helps protect your data and other important files from catastrophic incidents like theft, fire, or natural disasters. You can access the service on your computer using a password-protected account.

For more information, go to **delldatasafe.com**.

To schedule backups:

1. Double-click the Dell DataSafe Online icon  on the taskbar.
2. Follow the instructions that appear on the screen.

Dell Dock

The Dell Dock is a group of icons that provides easy access to frequently-used applications, files, and folders. You can personalize the Dock by:

- Adding or removing icons
- Grouping related icons into categories
- Changing the color and location of the Dock
- Changing the behavior of the icons



Add a Category

1. Right-click the Dock, click **Add**→ **Category**. The **Add/Edit Category** window is displayed.
2. Enter a title for the category in the **Title** field.
3. Select an icon for the category from the **Select an image:** box.
4. Click **Save**.

Add an Icon

Drag and drop the icon to the Dock or a category.

Remove a Category or Icon

1. Right-click the category or icon on the Dock and click **Delete shortcut** or **Delete category**.
2. Follow the instructions on the screen.

Personalize the Dock

1. Right-click the Dock and click **Advanced Setting....**
2. Choose the desired option to personalize the Dock.

Solving Problems

This section provides troubleshooting information for your computer. If you cannot solve your problem using the following guidelines, see “Using Support Tools” on page 48 or “Contacting Dell” on page 69.

Beep Codes

Your computer may emit a series of beeps during start-up if there are errors or problems. This series of beeps, called a beep code, identifies a problem. Write down the beep code and contact Dell (see “Contacting Dell” on page 69).

 **NOTE:** To replace parts, see the *Service Manual* at support.dell.com/manuals.

Beep Code	Possible Problem
One	Possible motherboard failure - BIOS ROM checksum failure
Two	No RAM detected NOTE: If you installed or replaced the memory module, ensure that the memory module is seated properly.
Three	Possible motherboard failure - Chipset error
Four	RAM read/write failure
Five	Real Time Clock failure
Six	Video card or chip failure
Seven	Processor failure
Eight	Display failure

Network Problems

Wireless Connections

If the wireless network connection is lost —

The wireless router is offline or wireless has been disabled on the computer.

- Ensure that wireless is enabled (see “Enable or Disable Wireless” on page 12).
- Check your wireless router to ensure it is powered on and connected to your data source (cable modem or network hub).
- Interference may be blocking or interrupting your wireless connection. Try moving the computer closer to your wireless router.
- Re-establish your connection to the wireless router (see “Setting Up a Wireless Connection” on page 15).

Wired Connections

If the wired network connection is lost — The cable is loose or damaged.

- Check the cable to ensure it is plugged in and not damaged.
- If the problem persists, contact your network administrator or ISP.

Power Problems

If the power or battery indicator light is off —

The computer is either turned off, in standby or hibernate mode, or not receiving power.

- Press the power button. The computer resumes normal operation if it is off or in hibernate mode.
- Press a key on the keyboard, move the connected mouse or a finger on the touch pad, or press the power button to resume normal operation.
- Reseat the AC adapter cable into both the power connector on the computer and the electrical outlet.
- If the AC adapter is plugged into a power strip, ensure that the power strip is plugged into an electrical outlet and that the power strip is turned on. Also bypass power protection devices, power strips, and power extension cables to verify that the computer turns on properly.

- Ensure that the electrical outlet is working by testing it with another device, such as a lamp.
- Check the AC adapter cable connections. If the AC adapter has a light, ensure that the light on the AC adapter is on.

If the power or battery indicator light is solid white and the computer is not responding —

The computer is either in standby or hibernate mode, or the display may not be responding.

- Press the power button until the computer turns off and then turn it back on.
- If the display is not responding, press the power button until the computer turns off and then turn the computer back on.
- Press a key on the keyboard, move the connected mouse or a finger on the touch pad, or press the power button to resume normal operation.
- If the problem persists, contact Dell (see “Contacting Dell” on page 69).

Solving Problems

If the power indicator light is breathing white — The computer is in standby mode.

- Press a key on the keyboard, move the connected mouse or a finger on the touch pad, or press the power button to resume normal operation.
- If the problem persists, contact Dell (see “Contacting Dell” on page 69).

If the battery indicator light is solid amber — The computer is in standby mode and the battery charge is low.

- Connect the AC adapter to power the computer and charge the battery.
- Press a key on the keyboard, move the connected mouse or a finger on the touch pad, or press the power button to resume normal operation.
- If the problem persists, contact Dell (see “Contacting Dell” on page 69).

If you encounter interference that hinders reception on your computer — An unwanted signal is creating interference by interrupting or blocking other signals. Some possible causes of interference are:

- Power, keyboard, and mouse extension cables.
- Too many devices connected to a power strip.
- Multiple power strips connected to the same electrical outlet.

Memory Problems

If you receive an insufficient memory message —

- Save and close any open files and exit any open programs you are not using to see if that resolves the problem.
- See the software documentation for minimum memory requirements.
- Reseat the memory modules into the connector(s) (see the *Service Manual* at support.dell.com/manuals).
- If the problem persists, contact Dell (see “Contacting Dell” on page 69).

If you experience other memory problems —

- Ensure that you are following the memory installation guidelines (see the *Service Manual* at support.dell.com/manuals).
- Check if the memory module is compatible with your computer. Your computer supports DDR3 memory. For more information about the type of memory supported by your computer, see “Basic Specifications” on page 72.
- Reseat the memory modules (see the *Service Manual* at support.dell.com/manuals) to ensure that your computer is successfully communicating with the memory.
- Run the Dell Diagnostics (see “Dell Diagnostics” on page 52).
- If the problem persists, contact Dell (see “Contacting Dell” on page 69).

Lockups and Software Problems

If the computer does not start up — Ensure that the power cable is firmly connected to the computer and to the electrical outlet.

If a program stops responding —

End the program:

1. Press <Ctrl><Shift><Esc> simultaneously.
2. Click **Applications**.
3. Click the program that is no longer responding
4. Click **End Task**.

If a program crashes repeatedly — Check the software documentation. If necessary, uninstall and then reinstall the program.

 **NOTE:** Software usually includes installation instructions in its documentation or on the CD.

If the computer stops responding or a solid blue screen appears —



WARNING: You might lose data if you are unable to perform an operating system shutdown.

If you are unable to get a response by pressing a key on your keyboard or moving your mouse, press the power button for at least 8 to 10 seconds until the computer turns off and then restart your computer.

If a program is designed for an earlier Microsoft® Windows® operating system —

Run the Program Compatibility Wizard. The Program Compatibility Wizard configures a program so that it runs in an environment similar to an earlier version of Microsoft Windows operating system environments.

To run the Program Compatibility Wizard:

Windows Vista[®]

1. Click **Start**  → **Control Panel** → **Programs** → **Use an older program with this version of Windows**.
2. In the welcome screen, click **Next**.
3. Follow the instructions on the screen.

Windows 7

1. Click **Start** .
2. In the search box, type `Use an older program with this version of Windows` and press <Enter>.
3. Follow the instructions on the **Program Compatibility** wizard.

If you have other software problems —

- Back up your files immediately.
 - Use a virus-scanning program to check the hard drive or CDs.
- Save and close any open files or programs and shut down your computer through the **Start**  menu.
 - Check the software documentation or contact the software manufacturer for troubleshooting information:
 - Ensure that the program is compatible with the operating system installed on your computer.
 - Ensure that your computer meets the minimum hardware requirements needed to run the software. See the software documentation for information.
 - Ensure that the program is installed and configured properly.
 - Verify that the device drivers do not conflict with the program.
 - If necessary, uninstall and then reinstall the program.

Using Support Tools

Dell Support Center

The **Dell Support Center** helps you find the service, support, and system-specific information you need.

To launch the application, click the  icon in the taskbar.

The **Dell Support Center** home page displays your computer's model number, service tag, express service code, and service contact information.

The home page also provides links to access:

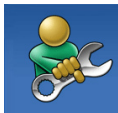

Self Help (Troubleshooting, Security, System Performance, Network/Internet, Backup/Recovery, and Windows operating system)



Alerts (technical support alerts relevant to your computer)



Assistance from Dell (Technical Support with DellConnect™, Customer Service, Training and Tutorials, How-To Help with Dell on Call™, and Online Scan with PC CheckUp)



About Your System (System Documentation, Warranty Information, System Information, Upgrades & Accessories)

For more information about **Dell Support Center** and available support tools, click the **Services** tab at support.dell.com.

System Messages

If your computer has an issue or error, it may display a system message that will help you identify the cause and action needed to resolve the issue.

 **NOTE:** If the message you received is not listed in the following examples, see the documentation for either the operating system or the program that was running when the message appeared. You can also refer to the *Dell Technology Guide* available on your hard drive or at support.dell.com/manuals or contact Dell (see “Contacting Dell” on page 69).

Alert! Previous attempts at booting this system have failed at checkpoint [nnnn]. For help in resolving this problem, please note this checkpoint and contact Dell Technical Support — The computer failed to complete the boot routine three consecutive times for the same error. Contact Dell (see “Contacting Dell” on page 69).

CMOS checksum error — Possible motherboard failure or Real Time Clock (RTC) battery low. Replace the coin-cell battery (see the *Service Manual* at support.dell.com/manuals) or contact Dell (see “Contacting Dell” on page 69).

CPU fan failure — CPU fan has failed. Replace the CPU fan (see the *Service Manual* at support.dell.com/manuals).

Hard-disk drive failure — Possible hard drive failure during POST. Contact Dell (see “Contacting Dell” on page 69).

Hard-disk drive read failure — Possible hard drive failure during HDD boot test. Contact Dell (see “Contacting Dell” on page 69).

Keyboard failure — Keyboard failure or loose cable. To replace the keyboard, see the *Service Manual* at support.dell.com/manuals.

Using Support Tools

No boot device available — No bootable partition on hard drive, the hard drive cable is loose, or no bootable device exists.

- If the hard drive is your boot device, ensure that the cables are connected and that the drive is installed properly and partitioned as a boot device.
- Enter system setup and ensure that the boot sequence information is correct (see the *Dell Technology Guide* available on your hard drive or at support.dell.com/manuals).

No timer tick interrupt — A chip on the system board might be malfunctioning or motherboard failure. Contact Dell (see “Contacting Dell” on page 69).

USB over current error — Disconnect the USB device. Your USB device needs more power for it to function properly. Use an external power source to connect the USB device, or if your device has two USB cables, connect both of them.

CAUTION - Hard Drive SELF MONITORING SYSTEM has reported that a parameter has exceeded its normal operating range. It is recommended that you back up your data regularly. A parameter out of range may or may not indicate a potential hard drive problem — S.M.A.R.T error, possible hard drive failure. Contact Dell (see “Contacting Dell” on page 69).

Hardware Troubleshooter

If a device is either not detected during the operating system setup or is detected but incorrectly configured, you can use the **Hardware Troubleshooter** to resolve the incompatibility.

To start the Hardware Troubleshooter:

1. Click **Start**  → **Help and Support**.
2. Type `hardware troubleshooter` in the search field and press <Enter> to start the search.
3. In the search results, select the option that best describes the problem and follow the remaining troubleshooting steps.

Dell Diagnostics

If you experience a problem with your computer, perform the checks in “Lockups and Software Problems” on page 46 and run the Dell Diagnostics before you contact Dell for technical assistance.

 **NOTE:** Dell Diagnostics works only on Dell computers.

 **NOTE:** The *Drivers and Utilities* disc is optional and may not ship with your computer.

Ensure that the device that you want to test displays in the system setup program and is active. Press <F2> during POST (Power On Self Test) to enter the System Setup (BIOS) utility.

Start the Dell Diagnostics from your hard drive or from the *Drivers and Utilities* disc.

Starting Dell Diagnostics From Your Hard Drive

The Dell Diagnostics is located on a hidden diagnostic utility partition on your hard drive.

 **NOTE:** If your computer cannot display a screen image, contact Dell (see “Contacting Dell” on page 69).

1. Ensure that the computer is connected to an electrical outlet that is known to be working properly.
2. Turn on (or restart) your computer.
3. When the DELL™ logo appears, press <F12> immediately. Select **Diagnostics** from the boot menu and press <Enter>. This may invoke the Pre-Boot System Assessment (PSA) on your computer.

 **NOTE:** If you wait too long and the operating system logo appears, continue to wait until you see the Microsoft® Windows® desktop, then shut down your computer and try again.

 **NOTE:** If you see a message stating that no diagnostics utility partition has been found, run the Dell Diagnostics from the *Drivers and Utilities* disc.

If PSA is invoked:



- a. The PSA starts running tests.
- b. If the PSA completes successfully, the following message appears: `No problems have been found with this system so far. Do you want to run the remaining memory tests? This will take about 30 minutes or more. Do you want to continue? (Recommended).`
- c. If you are experiencing memory issues, press <y>, otherwise press <n>. The following message appears: `Booting Dell Diagnostic Utility Partition. Press any key to continue.`
- d. Press any key to go to the **Choose An Option** window.

If PSA is not invoked:

Press any key to start the Dell Diagnostics from the diagnostics utility partition on your hard drive.

4. Select the test you want to run.
 5. If a problem is encountered during a test, a message appears with an error code and a description of the problem. Write down the error code and problem description and contact Dell (see “Contacting Dell” on page 69).
-  **NOTE:** The Service Tag for your computer is displayed at the top of each test screen. The Service Tag helps you identify your computer when you contact Dell.
6. When the tests are complete, close the test screen to return to the **Choose An Option** window.
 7. To exit the Dell Diagnostics and to restart the computer, click **Exit**.

Starting Dell Diagnostics From the Drivers and Utilities Disc

1. Insert the *Drivers and Utilities* disc.
2. Shut down and restart the computer.
When the DELL logo appears, press <F12> immediately.
 **NOTE:** If you wait too long and the operating system logo appears, continue to wait until you see the Microsoft Windows desktop, then shut down your computer and try again.
 **NOTE:** The next steps change the boot sequence for one time only. On the next start-up, the computer boots according to the devices specified in the system setup program.
3. When the boot device list appears, highlight **CD/DVD/CD-RW** and press <Enter>.
4. Select the **Boot from CD-ROM** option from the menu that appears and press <Enter>.
5. Type **1** to start the CD menu and press <Enter> to proceed.

6. Select **Run the 32 Bit Dell Diagnostics** from the numbered list. If multiple versions are listed, select the version appropriate for your computer.
7. Select the test you want to run.
8. If a problem is encountered during a test, a message appears with an error code and a description of the problem. Write down the error code and problem description and contact Dell (see “Contacting Dell” on page 69).
 **NOTE:** The Service Tag for your computer is displayed at the top of each test screen. The Service Tag helps you identify your computer when you contact Dell.
9. When the tests are complete, close the test screen to return to the **Choose An Option** window.
10. To exit the Dell Diagnostics and restart the computer, click **Exit**.
11. Remove the *Drivers and Utilities* disc.

Restoring Your Operating System

You can restore your operating system in the following ways:

- System Restore returns your computer to an earlier operating state without affecting data files. Use System Restore as the first solution for restoring your operating system and preserving data files.
- Dell Factory Image Restore returns your hard drive to the operating state it was in when you purchased the computer. This procedure permanently deletes all data on the hard drive and removes any programs installed after you received the computer. Use Dell Factory Image Restore only if System Restore did not resolve your operating system problem.
- If you received the *Operating System* disc with your computer, you can use it to restore your operating system. However, using the *Operating System* disc also deletes all data on the hard drive. Use the disc only if System Restore did not resolve your operating system problem.

System Restore

The Microsoft® Windows® operating systems provide a System Restore option which allows you to return your computer to an earlier operating state (without affecting data files) if changes to the hardware, software, or other system settings have left the computer in an undesirable operating state. Any changes that System Restore makes to your computer are completely reversible.

 **NOTE:** The procedures in this document are applicable for the Windows default view, so they may not apply if you set your Dell™ computer to the Windows Classic view.

To run System Restore:

1. Click **Start** .
2. Click **All Programs**→ **Accessories**→ **System Tools**→ **System Restore**.

 **NOTE:** The **User Account Control** window may appear. If you are an administrator on the computer, click **Continue**; otherwise, contact your administrator to continue.

3. Click **Next** and follow the instructions on the screen.

In the event that System Restore did not resolve the issue, you may undo the last system restore.

To undo the last System Restore:

 **NOTE:** Before you undo the last system restore, save and close all open files and exit any open programs. Do not alter, open, or delete any files or programs until the system restoration is complete.

1. Click **Start** .
2. Click **All Programs** → **Accessories** → **System Tools** → **System Restore**.

 **NOTE:** The **User Account Control** window may appear. If you are an administrator on the computer, click **Continue**; otherwise, contact your administrator to continue.

3. Click **Undo System Restore** and click **Next**.
4. Review your choices, and then click **Finish**. Your computer will restart and display a confirmation that the undo process is completed.

Dell Factory Image Restore

 **WARNING:** Using Dell Factory Image Restore permanently deletes all data on the hard drive and removes any programs or drivers installed after you received your computer. If possible, back up the data before using this option. Use Dell Factory Image Restore only if System Restore did not resolve your operating system problem.

 **NOTE:** Dell Factory Image Restore may not be available in certain countries or on certain computers.

Use Dell Factory Image Restore only as the last method to restore your operating system. This option restores your hard drive to the operating state it was in when you purchased the computer. Any programs or files added since you received your computer—

including data files—are permanently deleted from the hard drive. Data files include documents, spreadsheets, e-mail messages, digital photos, music files, and so on. If possible, back up all data before using Dell Factory Image Restore.

To restore the Dell factory image on your hard drive:

1. Turn on the computer. When the Dell logo appears, press <F8> several times to access the **Advanced Boot Options** window.
 **NOTE:** If you wait too long and the operating system logo appears, continue to wait until you see the Microsoft Windows desktop, then shut down your computer and try again.
2. Select **Repair Your Computer**. The **System Recovery Options** window appears.

3. Select a keyboard layout and click **Next**.
4. To access the recovery options, log on as a local user. To access the command prompt, type `administrator` in the **User name** field, then click **OK**.

5. Click **Dell Factory Image Restore**.

The **Dell Factory Image Restore** welcome screen appears.

-  **NOTE:** Depending upon your configuration, you may need to select **Dell Factory Tools**, then **Dell Factory Image Restore**.

6. Click **Next**.

The **Confirm Data Deletion** screen appears.

-  **NOTE:** If you do not want to proceed with Factory Image Restore, click **Cancel**.

7. Select the check box to confirm that you want to continue reformatting the hard drive and restoring the system software to the factory condition, then click **Next**.

The restore process begins and may take five or more minutes to complete. A message appears when the operating system and factory-installed applications have been restored to factory condition.

8. Click **Finish** to reboot the system.

Operating System Reinstallation

If you are considering reinstalling the Microsoft Windows operating system to correct a problem with a newly installed driver, first try using Windows Device Driver Rollback.

To roll back a device driver:

1. Click **Start** .
2. Right-click **Computer**.
3. Click **Properties** → **Device Manager**.
4. Right-click the device for which the new driver is installed, and click **Properties**.
5. Click the **Drivers** tab → **Roll Back Driver**.

If Device Driver Rollback does not resolve the problem, then use System Restore to return your operating system to the operating state it was in before you installed the new device driver. See “System Restore” on page 56.

 **CAUTION:** Before performing the installation, back up all data files on your primary hard drive. For conventional hard drive configurations, the primary hard drive is the first drive detected by the computer.

The following are required for reinstalling Microsoft Windows operating systems:

- Dell *Operating System* disc
- Dell *Drivers and Utilities* disc

 **NOTE:** The *Drivers and Utilities* disc contains drivers that were installed during the assembly of the computer. Use the Dell *Drivers and Utilities* disc to load any required drivers. Depending on the region from which you ordered your computer, or whether you requested the disc, the Dell *Drivers and Utilities* disc and *Operating System* disc may not ship with your computer.

The reinstallation process can take 1 to 2 hours to complete. After you reinstall the operating system, you must also reinstall the device drivers, virus protection program, and other software.

To reinstall Microsoft Windows operating system:

1. Save and close any open files and exit any open programs.
2. Insert the *Operating System* disc.
3. Click **Exit** if the **Install Windows** message appears.
4. Restart the computer.
5. When the DELL logo appears, press <F12> immediately.

 **NOTE:** If you wait too long and the operating system logo appears, continue to wait until you see the Microsoft Windows desktop, then shut down your computer and try again.

 **NOTE:** The next steps change the boot sequence for one time only. On the next start-up, the computer boots according to the devices specified in the system setup program.

6. When the boot device list appears, highlight **CD/DVD/CD-RW Drive** and press <Enter>.
7. Press any key to **Boot from CD-ROM**. Follow the instructions on the screen to complete the installation.

Use the *Drivers and Utilities* disc to install the drivers and utilities for your computer, as needed.

Getting Help

If you experience a problem with your computer, you can complete the following steps to diagnose and troubleshoot the problem:

1. See “Solving Problems” on page 41 for information and procedures that pertain to the problem your computer is experiencing.
2. See the *Dell Technology Guide* available on your hard drive or at **support.dell.com/manuals** for more troubleshooting information.
3. See “Dell Diagnostics” on page 52 for procedures on how to run Dell Diagnostics.
4. Fill out the “Diagnostic Checklist” on page 68.
5. Use Dell’s extensive suite of online services available at Dell Support (**support.dell.com**) for help with installation and troubleshooting procedures. See “Online Services” on page 64 for a more extensive list of Dell Support online.

6. If the preceding steps have not resolved the problem, see “Before You Call” on page 67.

 **NOTE:** Call Dell Support from a telephone near or at the computer so that the support staff can assist you with any necessary procedures.

 **NOTE:** Dell’s Express Service Code system may not be available in all countries.

When prompted by Dell’s automated telephone system, enter your Express Service Code to route the call directly to the proper support personnel. If you do not have an Express Service Code, open the **Dell Accessories** folder, double-click the **Express Service Code** icon, and follow the directions.

 **NOTE:** Some of the services are not always available in all locations outside the continental U.S. Call your local Dell representative for information on availability.

Technical Support and Customer Service

Dell's support service is available to answer your questions about Dell hardware. Our support staff use computer-based diagnostics to provide fast, accurate answers.

To contact Dell's support service, see "Before You Call" on page 67.

DellConnect

DellConnect™ is a simple online access tool that allows a Dell service and support associate to access your computer through a broadband connection, diagnose your problem and repair it all under your supervision. For more information, go to www.dell.com/dellconnect.

Online Services

You can learn about Dell products and services on the following websites:

- www.dell.com
- www.dell.com/ap (Asian/Pacific countries only)
- www.dell.com/jp (Japan only)
- www.euro.dell.com (Europe only)
- www.dell.com/la (Latin American and Caribbean countries)
- www.dell.ca (Canada only)

You can access Dell Support through the following websites and e-mail addresses:

Dell Support websites

- support.dell.com
- support.jp.dell.com (Japan only)
- support.euro.dell.com (Europe only)
- supportapj.dell.com (Asia Pacific only)

Dell Support e-mail addresses

- mobile_support@us.dell.com
- support@us.dell.com
- la-techsupport@dell.com (Latin America and Caribbean countries only)
- apsupport@dell.com (Asian/Pacific countries only)

Dell Marketing and Sales e-mail addresses

- apmarketing@dell.com (Asian/Pacific countries only)
- sales_canada@dell.com (Canada only)

Anonymous file transfer protocol (FTP)

- [ftp.dell.com](ftp://ftp.dell.com)
Log in as user: `anonymous`, and use your e-mail address as your password.

Automated Order-Status Service

To check on the status of any Dell products that you have ordered, you can go to **support.dell.com**, or you can call the automated order-status service. A recording prompts you for the information needed to locate and report on your order. For the telephone number to call your region, see “Contacting Dell” on page 69.

If you have a problem with your order, such as missing parts, wrong parts, or incorrect billing, contact Dell for customer assistance. Have your invoice or packing slip handy when you call. For the telephone number to call for your region, see “Contacting Dell” on page 69.

Product Information



If you need information about additional products available from Dell, or if you would like to place an order, visit the Dell website at **www.dell.com**. For the telephone number to call for your region or to speak to a sales specialist, see “Contacting Dell” on page 69.

Returning Items for Repair Under Warranty or for Credit

Prepare all items being returned, whether for repair or credit, as follows:

 **NOTE:** Before you return the product to Dell, make sure to back up any data on the hard drive and on any other storage device in the product. Remove any and all confidential, proprietary and personal information, as well as removable media, such as CDs and media cards. Dell is not responsible for any of your confidential, proprietary or personal information; lost or corrupted data; or damaged or lost removable media that may be included with your return.

1. Call Dell to obtain a Return Material Authorization Number, and write it clearly and prominently on the outside of the box. For the telephone number to call for your region, see “Contacting Dell” on page 69.

2. Include a copy of the invoice and a letter describing the reason for the return.
3. Include a copy of the Diagnostics Checklist (see “Diagnostic Checklist” on page 68), indicating the tests that you have run and any error messages reported by the Dell Diagnostics (see “Dell Diagnostics” on page 52).
4. Include any accessories that belong with the item(s) being returned (power cables, software, guides, and so on) if the return is for credit.
5. Pack the equipment to be returned in the original (or equivalent) packing materials.
 -  **NOTE:** You are responsible for paying shipping expenses. You are also responsible for insuring any product returned, and you assume the risk of loss during shipment to Dell. Collect On Delivery (C.O.D.) packages are not accepted.
 -  **NOTE:** Returns that are missing any of the preceding requirements will be refused at Dell’s receiving dock and returned to you.

Before You Call

NOTE: Have your Express Service Code ready when you call. The code helps Dell's automated-support telephone system direct your call more efficiently. You may also be asked for your Service Tag.

Locating Your Service Tag

The Service Tag for your computer can be found on a label on the bottom of your computer.

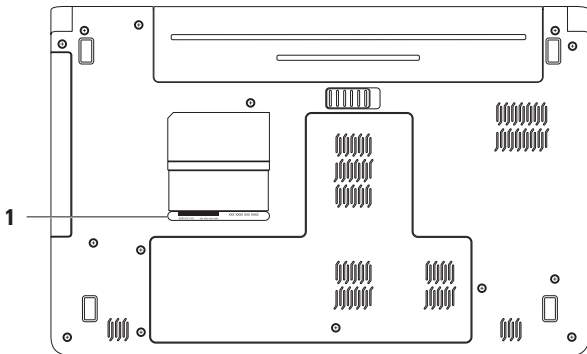

1 Service Tag

Diagnostic Checklist

Remember to fill out the following Diagnostics Checklist. If possible, turn on your computer before you call Dell for assistance and call from a telephone at or near the computer. You may be asked to type some commands at the keyboard, relay detailed information during operations, or try other troubleshooting steps possible only at the computer itself. Ensure that the computer documentation is available.

- Name:
- Date:
- Address:
- Phone number:
- Service Tag (bar code on the back or bottom of the computer):
- Express Service Code:
- Return Material Authorization Number (if provided by Dell support technician):
- Operating system and version:
- Devices:
- Expansion cards:
- Are you connected to a network? Yes/No
- Network, version, and network adapter:
- Programs and versions:

See your operating system documentation to determine the contents of the computer's start-up files. If the computer is connected to a printer, print each file. Otherwise, record the contents of each file before calling Dell.

- Error message, beep code, or diagnostic code:
- Description of problem and troubleshooting procedures you performed:

Contacting Dell

For customers in the United States, call 800-WWW-DELL (800-999-3355).

 **NOTE:** If you do not have an active Internet connection, you can find contact information on your purchase invoice, packing slip, bill, or Dell product catalog.

Dell provides several online and telephone-based support and service options. Availability varies by country and product, and some services may not be available in your area.

To contact Dell for sales, technical support, or customer service issues:

1. Visit **support.dell.com/contactdell**.
2. Select your country or region.
3. Select the appropriate service or support link based on your need.
4. Choose the method of contacting Dell that is convenient for you.

Finding More Information and Resources

If you need to:

reinstall your operating system

run a diagnostic program for your computer, reinstall computer system software, or update drivers for your computer, and readme files

learn more about your operating system, maintaining peripherals, RAID, Internet, Bluetooth®, networking, and e-mail

upgrade your computer with new or additional memory, or a new hard drive
reinstall or replace a worn or defective part

See:

the *Operating System* disc

the *Drivers and Utilities* disc



NOTE: Drivers and documentation updates can be found at **support.dell.com**.

the *Dell Technology Guide* available on your hard drive or at **support.dell.com/manuals**

the *Service Manual* at **support.dell.com/manuals**



NOTE: In some countries, opening and replacing parts of your computer may void your warranty. Check your warranty and return policies before working inside your computer.

If you need to:

find safety best practices information for your computer
review Warranty information, Terms and Conditions (U.S. only), Safety instructions, Regulatory information, Ergonomics information, and End User License Agreement

find your Service tag/Express Service Code — You must use the service tag to identify your computer on **support.dell.com** or to contact technical support

find drivers and downloads
access technical support and product help
check on your order status for new purchases
find solutions and answers to common questions
locate information for last-minute updates about technical changes to your computer or advanced technical-reference material for technicians or experienced users

See:



the safety and regulatory documents that shipped with your computer and also see the Regulatory Compliance Homepage at **www.dell.com/regulatory_compliance**

the bottom of your computer
the **Dell Support Center**. To launch the **Dell Support Center**, click the  icon in the taskbar.

support.dell.com

Basic Specifications

This section provides information that you may need when setting up, updating drivers for, and upgrading your computer. For more detailed specifications, see the *Comprehensive Specifications* at support.dell.com/manuals.

 **NOTE:** Offerings may vary by region. For more information regarding the configuration of your computer, click **Start**  → **Help and Support** and select the option to view information about your computer.

Computer Model

Dell™ Inspiron™ 1564

Computer Information

Processor types	Intel® Core™ i7 Intel Core i5 Intel Core i3 Intel Pentium® Intel Celeron®
System chipset	Intel HM55

Memory

Memory module connector	two user-accessible SODIMM connector
Memory type	DDR3 1066 MHz
Possible memory configurations	2 GB, 3 GB, 4 GB, 6 GB, and 8 GB

 **NOTE:** For instructions on upgrading memory, see the *Service Manual* at support.dell.com/manuals.

Connectors

Audio	one microphone-in connector, one stereo headphone/speaker connector
Mini-Card	one Type IIIA full Mini-Card slot, one half-size Mini-Card slot
HDMI	one 19-pin connector
Network	one RJ45 connector
USB	three 4-pin USB 2.0-compliant connectors
Video	one 15-hole connector
Media card reader	one 7-in-1 slot

Communications

Network	10/100 Ethernet LAN on system board
Wireless	internal WLAN Mini-Card with WiFi 802.11a/b/g/n, WWAN, and Bluetooth® wireless technology

Camera

Camera resolution	1.3 megapixel
Video resolution	640 x 480 at 30 fps (maximum)

Basic Specifications

Display

Type	15.6-inch HD WLED with TrueLife
Height	193.54 mm (7.62 inches)
Width	344.23 mm (13.55 inches)
Diagonal	396.42 mm (15.6 inches)

Battery

6-cell "smart" lithium ion

Depth	53.1 mm (2.09 inches)
Height	22.3 mm (0.88 inches)
Width	274.5 mm (10.8 inches)
Weight	0.35 kg (0.77 lb)

Battery

9-cell "smart" lithium ion

Depth	53.1 mm (2.09 inches)
Height	42.9 mm (1.69 inches)
Width	314.45 mm (12.38 inches)
Weight	0.52 kg (1.15 lb)
Voltage	11.1 VDC
Charge time (approximate)	4 hours (when the computer is turned off)
Operating time (approximate)	Battery operating time varies depending on operating conditions.
Coin-cell battery	CR-2032

AC Adapter

 **NOTE:** Use only AC adapters specified for use with your computer. See the safety information that shipped with your computer.

Input voltage	100–240 VAC
Input current	1.5 A
Input frequency	50–60 Hz
Output power	65 W or 90 W
Output current	3.34 A (65 W) (continuous) 4.62 A (90 W) (continuous)
Rated output voltage	19.5 ± 1 VDC
Operating temperature	0° to 35°C (32° to 95°F)
Storage temperature	–40° to 65°C (–40° to 149°F)

Physical

Height	20.0 mm to 32.8 mm (0.78 inches to 1.3 inches)
Width	380.0 mm (14.96 inches)
Depth	248 mm (9.76 inches)
Weight (with 6-cell battery)	configurable to less than 2.54 kg (5.6 lb)

Computer Environment

Temperature range:

Operating	0° to 35°C (32° to 95°F)
Storage	-40° to 65°C (-40° to 149°F)

Relative humidity (maximum):

Operating	10% to 90% (non condensing)
Storage	5% to 95% (non condensing)

*Maximum vibration (using a random vibration
spectrum that simulates user environment):*

Operating	0.66 GRMS
Non-Operating	1.30 GRMS

Computer Environment

*Maximum shock (for operating — measured
with Dell Diagnostics running on the hard
drive and a 2-ms half-sine pulse;
for non-operating — measured with hard
drive in head-parked position and a 2-ms
half-sine pulse):*

Operating	110 G
Non-Operating	160 G

Altitude (maximum):

Operating	-15.2 to 3048 m (-50 to 10,000 ft)
Storage	-15.2 to 10,668 m (-50 to 35,000 ft)
Airborne contaminant level	G2 or lower as defined by ISA-S71.04-1985

Appendix

Macrovision Product Notice

This product incorporates copyright protection technology that is protected by method claims of certain U.S. patents and other intellectual property rights owned by Macrovision Corporation and other rights owners. Use of this copyright protection technology must be authorized by Macrovision Corporation, and is intended for home and other limited viewing uses only unless otherwise authorized by Macrovision Corporation. Reverse engineering or disassembly is prohibited.

Information for NOM, or Official Mexican Standard (Only for Mexico)

The following information is provided in the device(s) described in this document in accordance with the requirements of the Official Mexican Standard (NOM):

Importer:

Dell México S.A. de C.V.

Paseo de la Reforma 2620 - Flat 11°

Col. Lomas Altas

11950 México, D.F.

Regulatory Model Number	Voltage	Frequency	Electricity Consumption	Output Intensity
P08F	100–240 VAC	50–60 Hz	1.5 A	3.34 A/4.62 A

For details, read the safety information that shipped with your computer.

For additional safety best practices information, see the Regulatory Compliance Homepage at www.dell.com/regulatory_compliance.

Index

A

AC adapter

- connecting **6**
- light status **23**
- specifications **75**

airflow

- computer safety **5**

audio

- connecting **19**

B

backup and recovery **39**

backups

- creating **38**

battery

- 6-cell **74**
- 9-cell **74**
- coin-cell **74**
- light status **23**

C

camera **33**

- video resolution **73**

CDs, playing and creating **36**

chipset **72**

computer

- capabilities **36**
- dimensions **75**
- setting up **5**

- connecting
 - AC adapter **6**
 - network cable **7**
 - to the Internet **14**
- conserving energy **37**
- Contacting Dell online **69**
- customizing
 - your desktop **36**
 - your energy settings **37**
- D**
- damage, avoiding **5**
- data, backing up **38**
- Dell Diagnostics **52**
- Dell Factory Image Restore **57**
- display
 - size **74**
 - types **74**

- drivers and downloads **71**
- DVDs, playing and creating **36**

E

- e-mail technical support
 - 64**
- energy, conserving **37**

F

- FTP login, anonymous **64**

H

- HDMI **73**
 - connecting **21**
- headphones, connecting **19**
- help, getting assistance and support **62**

I

Internet connection **14**

ISP, Internet Service Provider **14**

M

Macrovision

78

media card reader **19**

memory

configurations **72**

types **72**

microphone

analog **23**

connecting external **19**

Mini-Cards **73**

multimedia

changing tracks **29**

muting **29**

pausing **29**

playing **29**

volume **29**

N

network

connector **73**

NOM **79**

O

optical drive **19**

P

power/battery indicator lights **23**

powering up the computer **8**

processors **72**

R

recovering data **39**

restoring factory image **58**

S

security cable, connecting **21**

setup, before you begin **5**

SIM card **10**

support e-mail addresses **64**

system reinstall options **55**

System Restore **55**

T

touch pad

26

U

USB **19, 21**

V

ventilation, ensuring **5**

VGA

connecting **21**

video

connector **73**

W

Windows

reinstalling **61**

setting up **9**

wired network

network cable, connecting **7**

wireless

cards **73**

setting up **15**



Printed in the U.S.A.

www.dell.com | support.dell.com



08X93CA00